

3M™ Telecommunications

Solutions for Networks

3M™ Hot Melt Fibre Optic

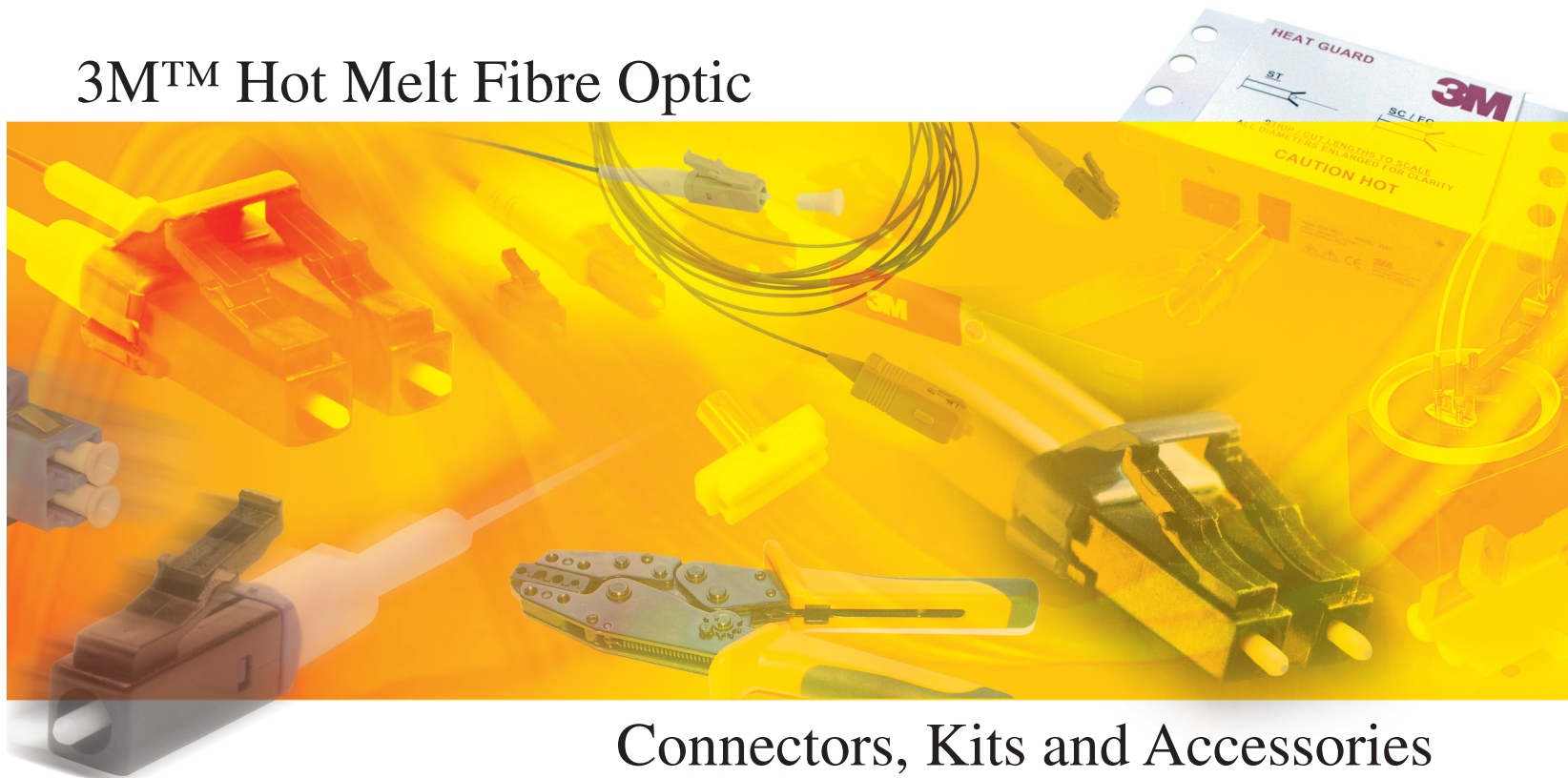

Connectors, Kits and Accessories

3M *Innovation*

3M™ Hot Melt Connectors are among the most popular with contractors because of their reliability and ease of use. They come pre-loaded with an adhesive that is not limited in shelf life, and the termination procedure provides the ability to reheat and reposition the fibre in the termination process. This easy-to-install field mount connector provides reliable performance in indoor and outdoor applications and has no internal splice.

All 3M™ Hot Melt connectors can be terminated using the same 3M™ Hot Melt Termination Kit 6365/6361. 3M™ LC Connectors require the 3M™ LC Expansion Kit 6650-LC which includes a weighted polishing jig to provide a PC centred apex end face.

APPLICATIONS:

The applications for the hot melt connector are based on industry standards for performance over environmental extremes.

3M™ HOT MELT CONNECTORS

- Singlemode and multimode local area networks and campus wiring
- Singlemode telephony central office and CATV headend
- Environmental performance requirements exceeding ISO 11801, EN 50173 and EIA/TIA 568-B.3
- Singlemode reflection requirements of -55dB
- Available in LC, ST, SC, FC singlemode and multimode connectors
- Provides reliable performance in a wide range of indoor and outdoor applications



3M™ Hot Melt LC-Duplex Connector



3M™ Hot Melt ST-Connector

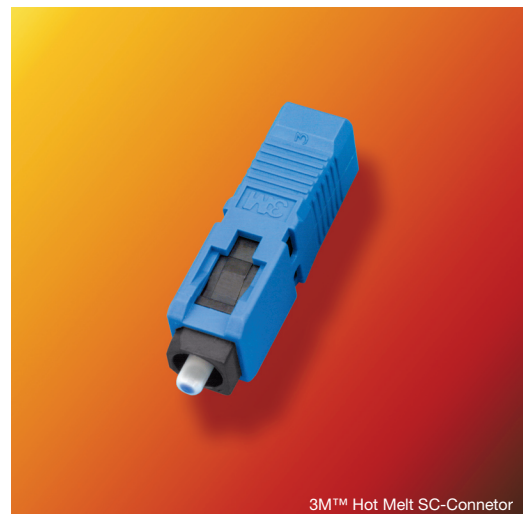

3M™ Hot Melt SC-Connector

FEATURES AND BENEFITS

3M™ HOT MELT CONNECTORS – LC, ST, SC, FC	
Meets ISO 11801, EN 50173 and EIA/TIA 568-B.3 standards for indoor and outdoor applications	Long term reliability
Ease of use on backbone and horizontal cable	Quick termination in <2 minutes; high yield
Allows custom length cable assemblies to be built on site	Enhances cable management in telecom room or central office
	Minimizes cable slack
Adhesive fibre retention	Not dependent on mechanical retention alone
3M field polishing process produces <55dB reflection, singlemode	Reliable in high speed transmission
Pre-loaded adhesive	No epoxy mixing or mess; no shelf life
Re-heatable adhesive	Allows fibre repositioning
Blue dot of adhesive	Easy to see when polishing is complete

FEATURES AND BENEFITS

SPECIFICATIONS	MULTIMODE	SINGLEMODE
Product Number	6100 ST Series 6200 FC Series 6300 SC Series 6600 LC Series	8100 ST Series 8200 FC Series 8300 SC Series 8600 LC Series
Testing Specification	ISO 11801, EN 50173 and EIA/TIA 568-B.3	
Operating Temperature*	-10°C to +60°C	
Attenuation**	<0.2dB typical	
Reflection***	-25dB typical	-55dB typical
Mating Durability 300 Matings	<0.2dB change	
Storage Temperature	-40°C to +85°C	
Materials and Identification		
Ferrule	Zirconia ceramic	
Housing Body	Nickel plated zinc (ST) Engineered resin (LC, SC, FC)	
Boot	Thermoplastic elastomer	
Flame Retardancy	UL-94 V-0	
Adhesive	Blue dot on ferrule	

*Multimode connectors tested at 850nm and 1300nm.

**Singlemode connectors tested at 1310nm and 1550nm.

***Tested for 96 hours at 85°C, exceeding IEC standards.

3M™ ST Hot Melt Connector

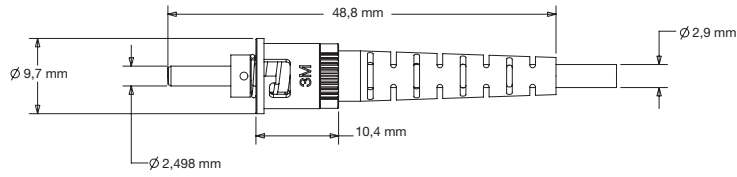

3M™ SC Hot Melt Connector

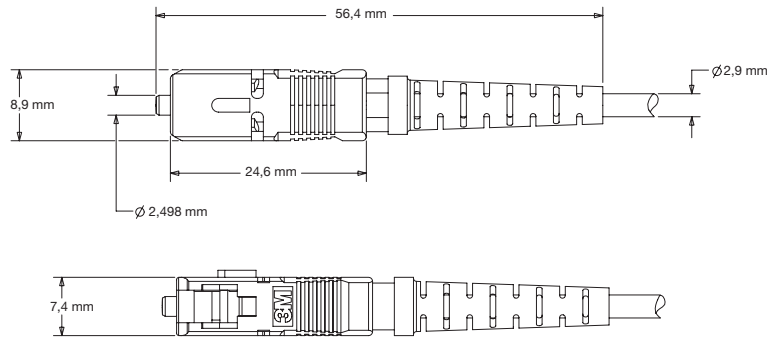

3M™ FC Hot Melt Connector

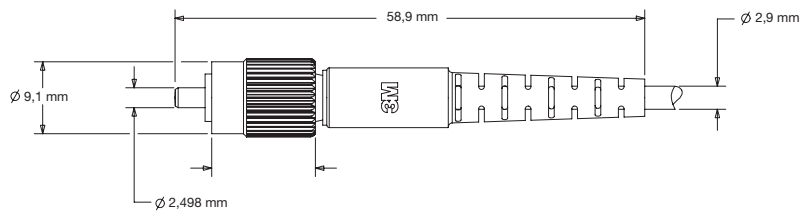

3M™ LC Hot Melt Connector

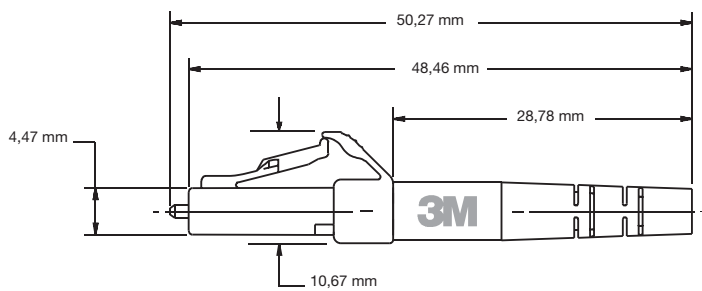

LC UNIBODY DUPLEX CONNECTOR ASSEMBLIES WITH JACKETED CABLE BOOT

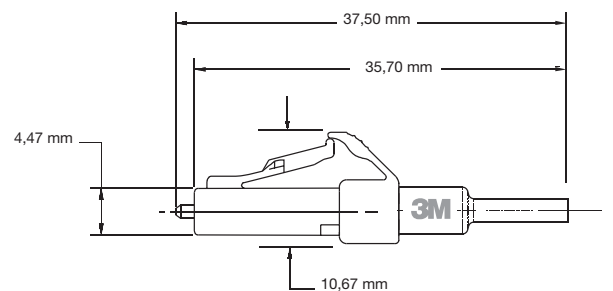

LC UNIBODY DUPLEX CONNECTOR ASSEMBLIES WITH UNJACKETED CABLE BOOT

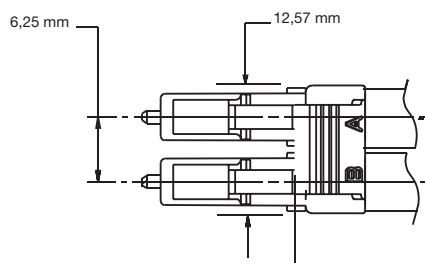

LC UNIBODY DUPLEX CONNECTOR ASSEMBLIES

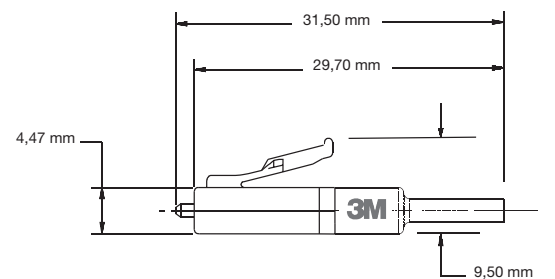

LC BTW CONNECTOR (BEHIND THE WALL) UNJACKETED FIBRE AND SIMPLEX ONLY

ORDERING INFORMATION - 3M™ HOT MELT CONNECTORS

PRODUCT NUMBER	DESCRIPTION	MOQ	PACKAGING
3M™ LC Connectors			
6600-S	MM hot melt simplex 900 BTW, white boot	60	1/bag, 60/carton
6602-S	MM hot melt simplex 1.6-2.0 cable, white boot	60	1/bag, 60/carton
6603-S	MM hot melt simplex 2.4-3.0 cable, white boot	60	1/bag, 60/carton
6601-D	MM hot melt duplex 900 buffer, white/beige boots	60	1/bag, 60/carton
6602-D	MM hot melt duplex 1.6-2.0 cable, white/beige boots	60	1/bag, 60/carton
6603-D	MM hot melt duplex 2.4-3.0 cable, white/beige boots	60	1/bag, 60/carton
6604-D	MM hot melt duplex 900 buffer, red/black boots	60	1/bag, 60/carton
6605-D	MM hot melt duplex 1.6-2.0 cable, red/black boots	60	1/bag, 60/carton
6606-D	MM hot melt duplex 2.4-3.0 cable, red/black boots	60	1/bag, 60/carton
8600-S	SM hot melt simplex 900 BTW, white boot	60	1/bag, 60/carton
8602-S	SM hot melt simplex 1.6-2.0 cable, white boot	60	1/bag, 60/carton
8603-S	SM hot melt simplex 2.4-3.0 cable, white boot	60	1/bag, 60/carton
8601-D	SM hot melt duplex 900 buffer, white/beige boots	60	1/bag, 60/carton
8602-D	SM hot melt duplex 1.6-2.0 cable, white/beige boots	60	1/bag, 60/carton
8603-D	SM hot melt duplex 2.4-3.0 cable, white/beige boots	60	1/bag, 60/carton
3M™ ST Connectors			
6100-W	MM hot melt connector, white boot	60	1/bag, 60/carton
6100-B	MM hot melt connector, black boot	60	1/bag, 60/carton
6100-R	MM hot melt connector, red boot	60	1/bag, 60/carton
6100-W1K-S	MM hot melt connector, white boot	1,000	1/bag, 1,000/carton
6100-B1K-S	MM hot melt connector, black boot	1,000	1/bag, 1,000/carton
6100-R1K-S	MM hot melt connector, red boot	1,000	1/bag, 1,000/carton
8100-YS	SM hot melt connector, yellow boot	60	1/bag, 60/carton
8100-Y1K-S	SM hot melt connector, yellow boot	1,000	1/bag, 1,000/carton
3M™ FC Connectors			
6200	MM hot melt connector, white boot	60	1/bag, 60/carton
8200-W	SM hot melt connector, white boot	60	1/bag, 60/carton
3M™ SC Connectors			
6300-W	MM hot melt connector, white boot	60	1/bag, 60/carton
6300-W1K-S	MM hot melt connector, white boot	1,000	1/bag, 1,000/carton
6300-B1K	MM hot melt connector, black boot	1,000	1/bag, 1,000/carton
6300-R1K-S	MM hot melt connector, red boot	1,000	1/bag, 1,000/carton
8300	SM hot melt connector, white boot	60	1/bag, 60/carton
8300-W1K-S	SM hot melt connector, white boot	1,000	1/bag, 1,000/carton

3M™ HOT MELT TERMINATION KITS

The 3M™ Hot Melt Termination Kits 6365 (120V oven) and 6361 (230V oven) contain all materials necessary to terminate 3M SC, ST, and FC hot melt, both singlemode and multimode. An LC expansion kit 6650-LC makes it easy to incorporate the LC Hot Melt process into one kit.



3M™ Hot Melt Termination Kits 6365 and 6361

FEATURES AND BENEFITS

Improved microscope with oblique and coaxial lighting	Better view of fibre end face inspection
Roll-up tool pouch	Tools are organized and accessible
Universal hot melt holders	Fewer parts to carry, holds cable more securely
Instruction CD	Organized into video segments

ORDERING INFORMATION - HOT MELT TERMINATION KITS

PRODUCT NUMBER	DESCRIPTION	MOQ	PACKAGING
6365	Hot melt termination kit for ST, FC, SC hot melt connectors, 120V	1	1 each
6361	Hot melt termination kit for ST, FC, SC hot melt connectors, 230V	1	1 each
6650-LC	LC expansion kit	1	1 each
6156	Conversion kit (epoxy to hot melt 120V)	1	1 each
6157	Conversion kit (epoxy to hot melt 230V)	1	1 each

ORDERING INFORMATION - HOT MELT ACCESSORIES

PRODUCT NUMBER	DESCRIPTION	MOQ	PACKAGING
6851-E	Autopolisher for ST,SC and FC Hot Melt connectors	1	1 kit
6192-B	Lapping film for 6851-E Autopolisher	4 pkg	50 shts/pkg
6365-CC	Hot melt consumable kit for ST, SC, FC Lapping film, 2 µm (254X) Lapping film, 0.05 µm (263X) Lint free cloths 8892 universal polishing jig	1	1 each 200 sheets 50 sheets 200 sheets 1 each
6650-LS	Lapping film singlemode consumable kit (polishes 400 connectors) Lapping film, 9 µm (441X) Lapping film, 2 µm (254X) Lapping film, 0.5 µm (661X) Lapping film, final polish (863XW)		1 each 20 sheets 100 sheets 40 sheets 1 each
6650-LM	Lapping film multimode consumable kit (polishes 400 connectors) Lapping film, 9 µm (441X) Lapping film, 2 µm (254X)	1	1 each

3M™ HOT MELT TERMINATION KITS 6365/6361 CONTENTS

PRODUCT NUMBER	DESCRIPTION	CONTENTS QTY	REPLACEMENT MOQ	PACKAGING
6312	120V oven (6365 Kit)	1	1	1
6323	230V oven (6361 Kit)	1	1	1
6365-UH	Universal holder	4	4	4/pkg
6365-PP	Round polishing pad	1	1	1
8365-PP	Soft polishing pad	2	1	1
6192-A	2 µm lapping film (pale green)	200	500	500/pkg
661X-1.5S	1.5 µm diamond film (pale grey)	15	15	250/pkg
863X-0.02S	Final lapping film (frosted)	50	50	50/pkg
263X	0.05 µm lapping film (pale yellow)	50	50	50/pkg
8892	Polishing jig	3	1	1
6365-JS	Jacket stripper	1	1	1
6365-KS	Kevlar snips	1	1	1
6365-ST	Stripping tool	1	1	1
6365-CT	Crimp tool	1	1	1
6365-FS	Fibre scribe	1	1	1
6365-VS	View scope (200X)	1	1	1
	Pronto adhesive	1	-	-
05-00017	Lint-free cloths	100	100	100/pkg
	120V power cord (6365 Kit)	1	-	-
	230V UK power cord (6361 Kit)	1	-	-
	230V EU power cord (6361 Kit)	1	-	-
	Alcohol bottle (empty)	1	-	-
	Water bottle (empty)	1	-	-
	Fibre scrap can	1	-	-
	Roll up pouch	1	-	-
	Fibre marking pen	1	-	-
	Training CD ROM	1	-	-
	Instructions (paper)	1	-	-

The 3M™ LC Expansion Kit 6650-LC is used in addition to the 6365/6361 hot melt termination kits. The LC expansion kit contains the tools needed to terminate 3M™ LC Hot Melt Connectors that are not included in the 6365/6361 termination kits.

3M™ LC HOT MELT EXPANSION KIT 6650 CONTENTS

PRODUCT NUMBER	DESCRIPTION	CONTENTS QTY	REPLACEMENT MOQ	PACKAGING
6650-LH	Hot melt connector holder	4	4	4/pkg
6650-JW	Polishing jig w/ weight (includes 2 jigs)	1	1	1
6650-LS	Replacement polishing jigs	0	2	1
6650-LT	Crimp tool	1	1	1
6650-VS	Adapter for view scope	1	1	1
6650-HS	Heat shrink fixture	1	1	1
6650-HC	Holder cleaning pin	3	3	3/pkg
6650-LP	Polishing pad 4.5 x 5.5	2	2	2/pkg
	Instruction manual	1	-	-
	Lapping film, start-up kit*	1	-	-
	Laminated stripping template	1	-	-

*up to 100 total polished multimode ends, or up to 50 singlemode ends with 50 multimode ends

A complete line of ST, FC, SC and LC couplings is available.
For more information, please contact your local sales representative.

important important Notice

3M does not accept responsibility or liability, direct or consequential, arising from reliance upon any information provided and the user should determine the suitability of the products for their intended use. Nothing in this statement will be deemed to exclude or restrict 3M's liability for death or personal injury arising from its negligence.

All questions of liability relating to 3M products are governed by the seller's terms of sale subject where applicable to the prevailing law.

If any goods supplied or processed by or on behalf of 3M prove on inspection to be defective in material or workmanship, 3M will (at its option) replace the same or refund to the Buyer the price of the goods or services.

Except as set out above, all warranties and conditions, whether expressed or implied, statutory or otherwise are excluded to the fullest extent permissible at law.

3M, Crimplok and Fibrok are trademarks of 3M.

ST is a registered trademark of Lucent Technologies.



3M Telecommunications

Europe, Middle East & North Africa

Carl-Schurz-Straße 1

41453 Neuss Germany

Tel: ++49 (0)2131 / 14-5999

Fax: ++49 (0)2131 / 14-5998

Email: 3MTelecommunications.de@mmm.com

Internet: www.3MTelecommunications.com